











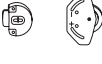

SEZNAM DÍLŮ
PART LIST

	IMBUS ALLAN KEY	1x		KOLÍK DOWELL	16x
	KOVÁNÍ NA DVEŘE DOOR HARDWARE	4x		KONFIRMÁT CONFIRMAT	12x
	ÚCHYTKA PULL	2x		POLICOVÝ KOLÍK SHELF SUPPORT	12x
	VODICÍ LIŠTA PLASTIC STRIP	4x		KRYTKA SCREW COVER	12x
	DRŽÁK ŠATNÍ TYČE ROD SOCKET	2x		HŘEBÍKY NAILS	35x
	ŠATNÍ TYČ ROD	1x		VRUTY KOVÁNÍ SCREW HARDWARE	16x
				VRUTY ÚCHYTKY SCREW PULL	4x



3

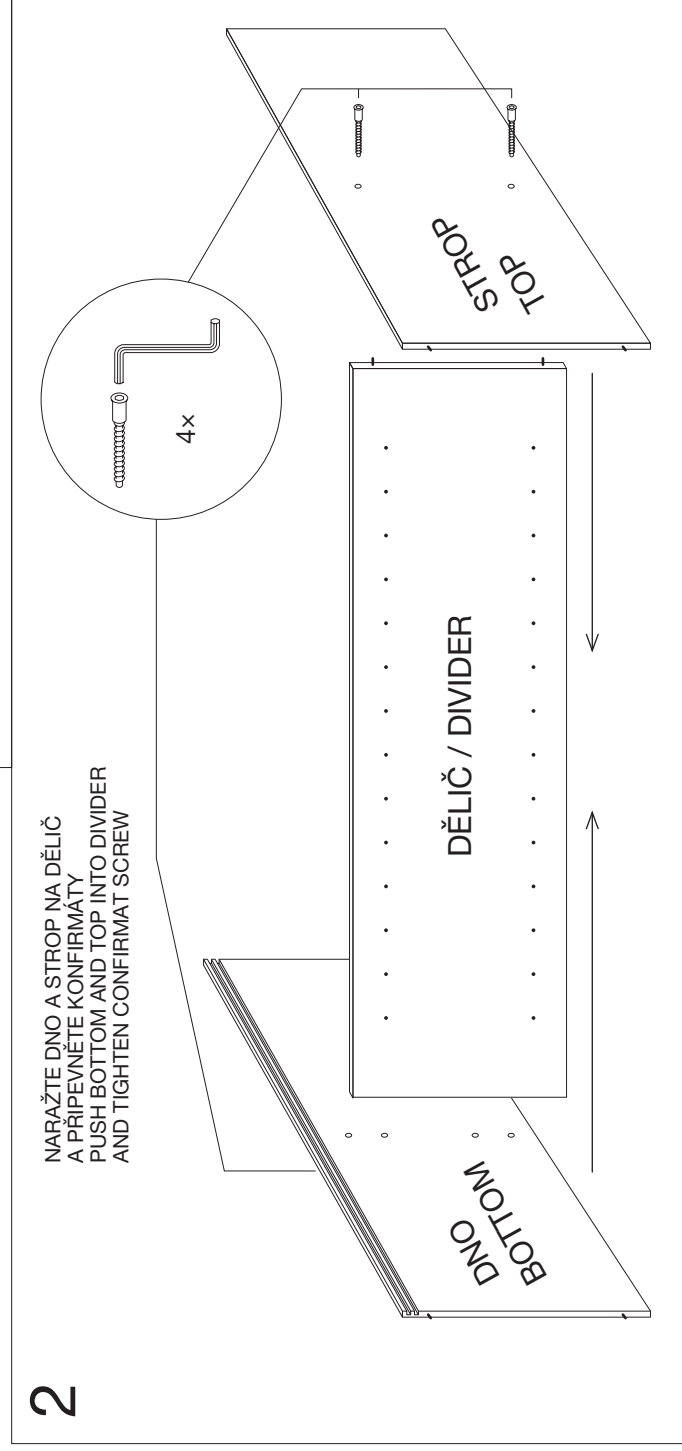
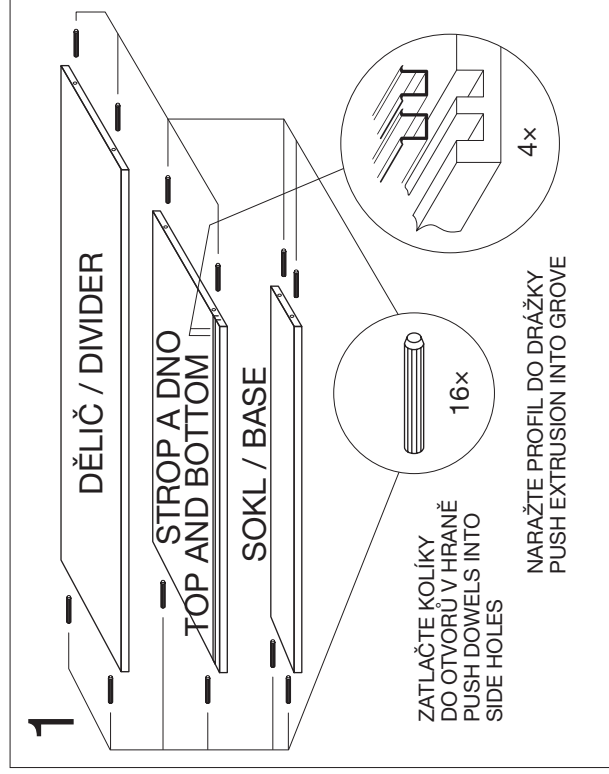
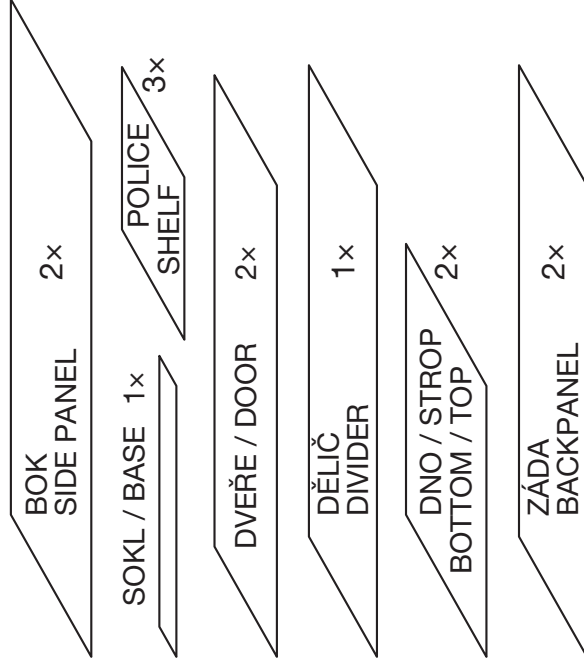
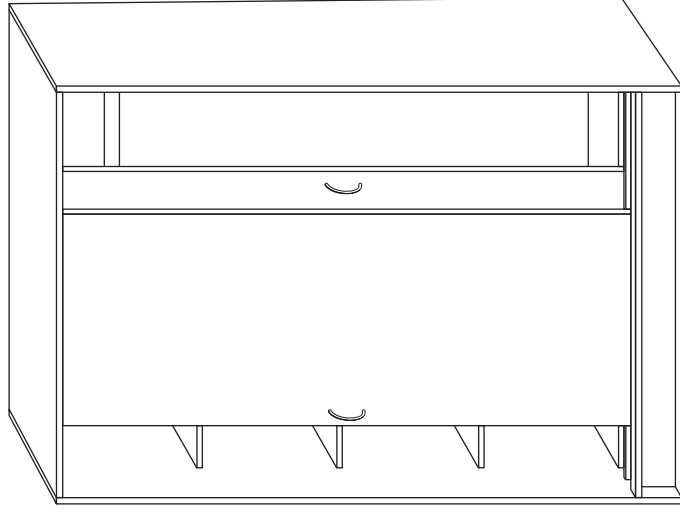
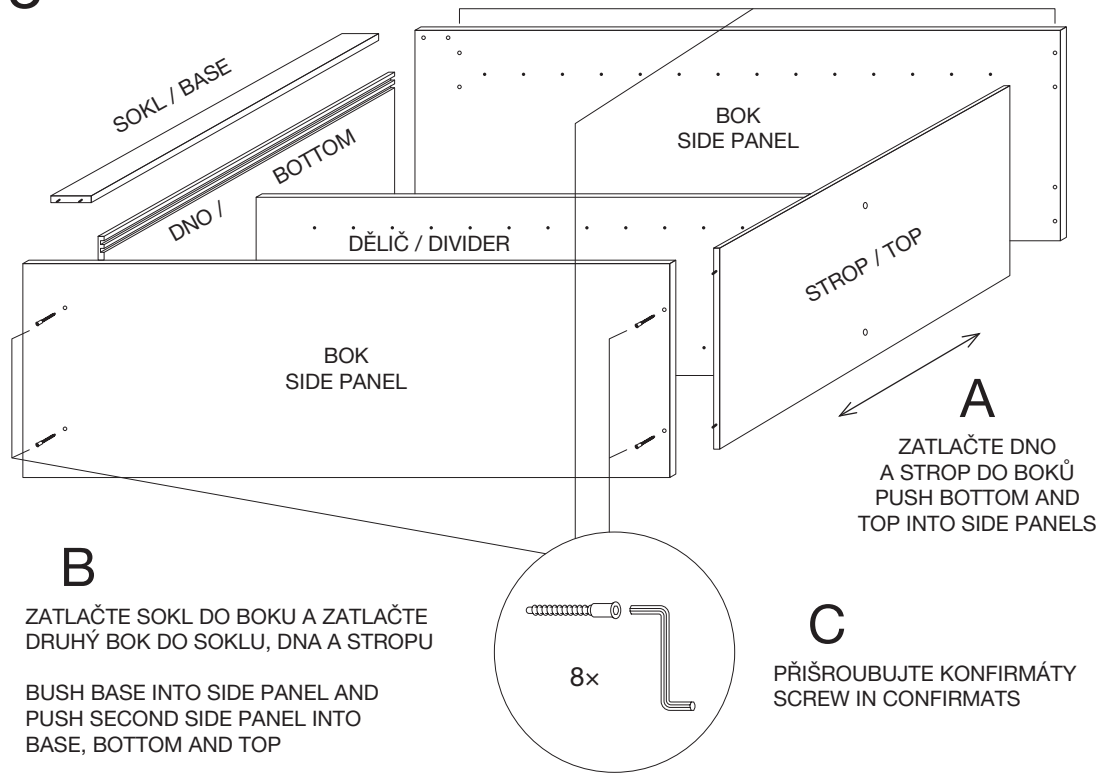

5

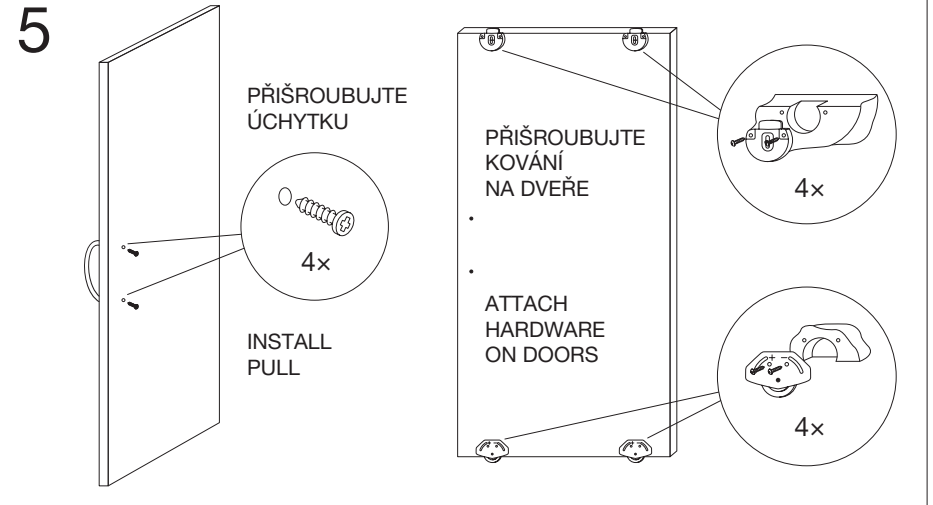

6

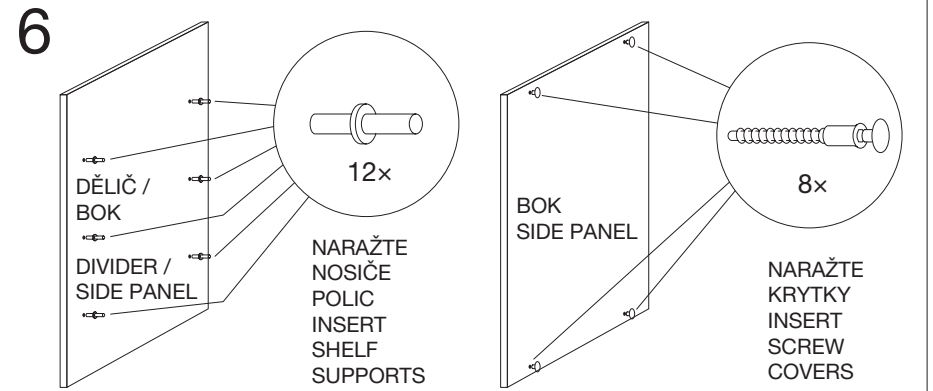

4

PŘIBIJTE ZÁDA NA NEOLEPENÉ HRANY
NAIL BACKPANEL TO NONEDGE BAND EDGES

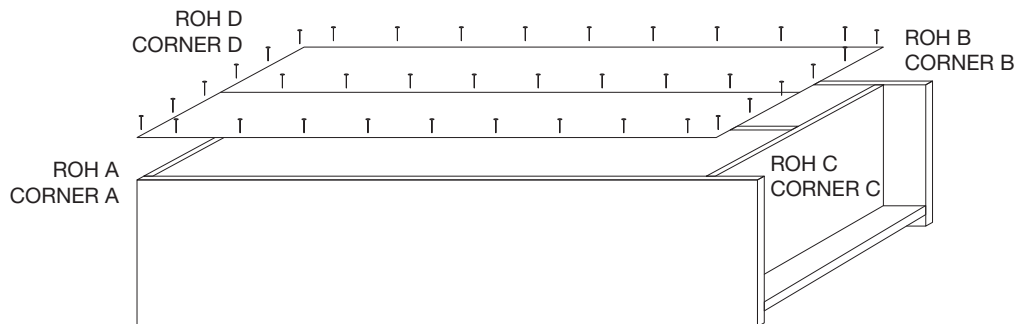

POZOR!!! PŘED PŘIBITÍM ZAD ZMĚŘTE VZDÁLENOST MEZI ROHY A-B, C-D. TATO VZDÁLENOST MUSÍ BÝT STEJNÁ.
ATTENTION!!! BEFORE NAILING BACKPANEL MEASURE THE DISTANCE A-B, C-D. THIS DISTANCE MUST BE THE SAME.

7



8

